

**4 Montants "angle"**

6 inserts

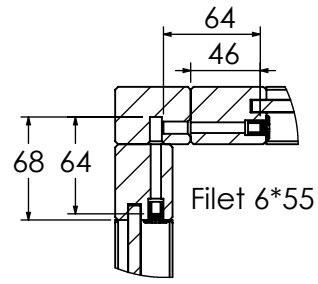

attention sur MT bloc porte  
la tête de vis sera noyée

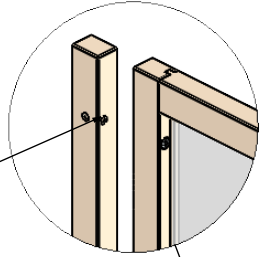
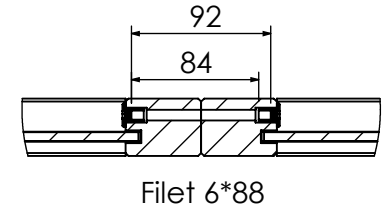
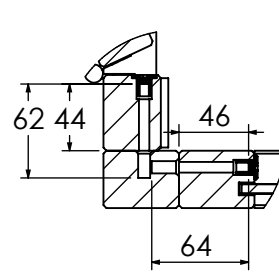

**1 Montant "Cache"**

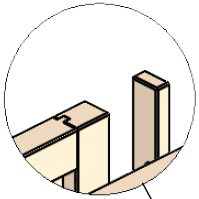

6 angles

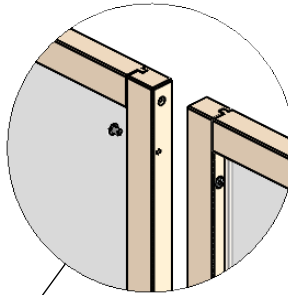

**hauteur 1900**

**1 Montant "T"**

9 inserts

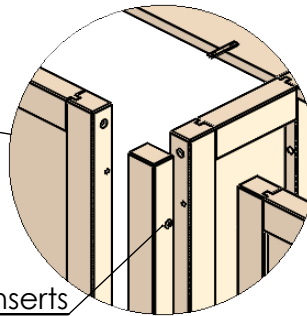

Pas de vérin sur les montants de jonction

Verin sur poteaux cloison

2 supports

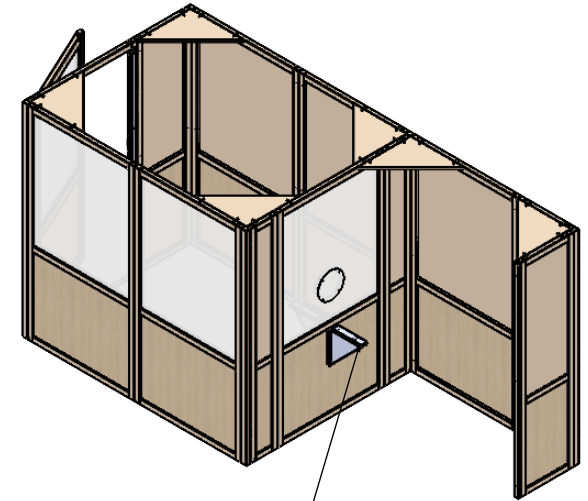

**Tolérance générale: ± 0.3**

Indice: **A**

Date: **24/04/2020**

Ech: **1:50**

**Evidences Mobiliers**

6 rue de l'industrie  
85250 La Rabatelière  
Tel: 0820 00 21 21

Designation ensemble:  
**Vestibul 2**

Designation pièce:  
**SAS**

Verre ep 6mm  
Pnx ep 8mm

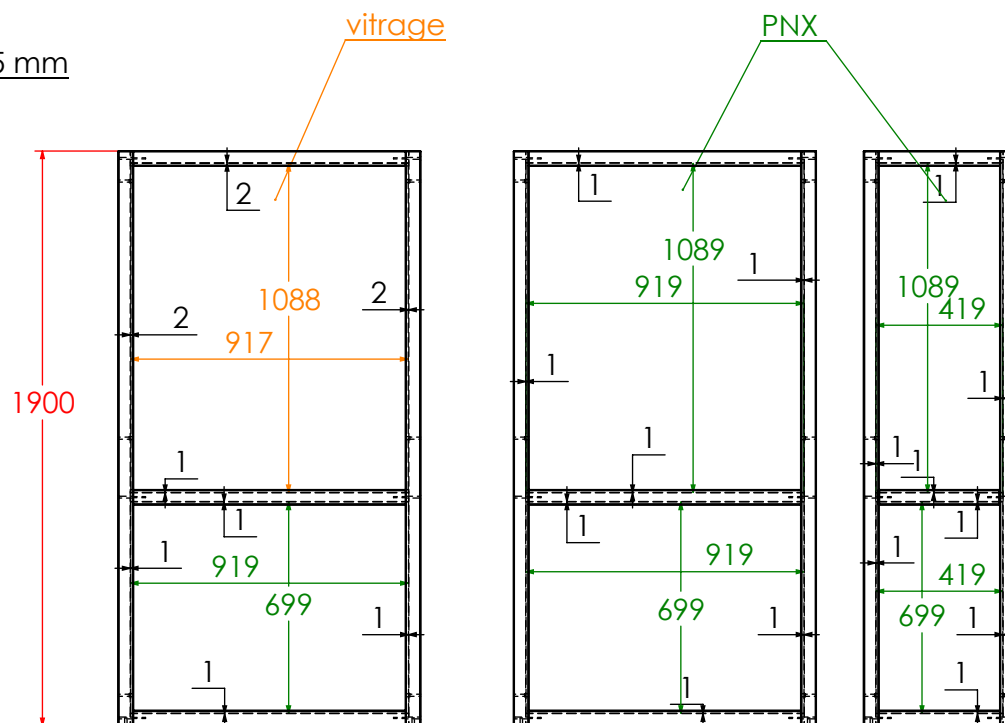
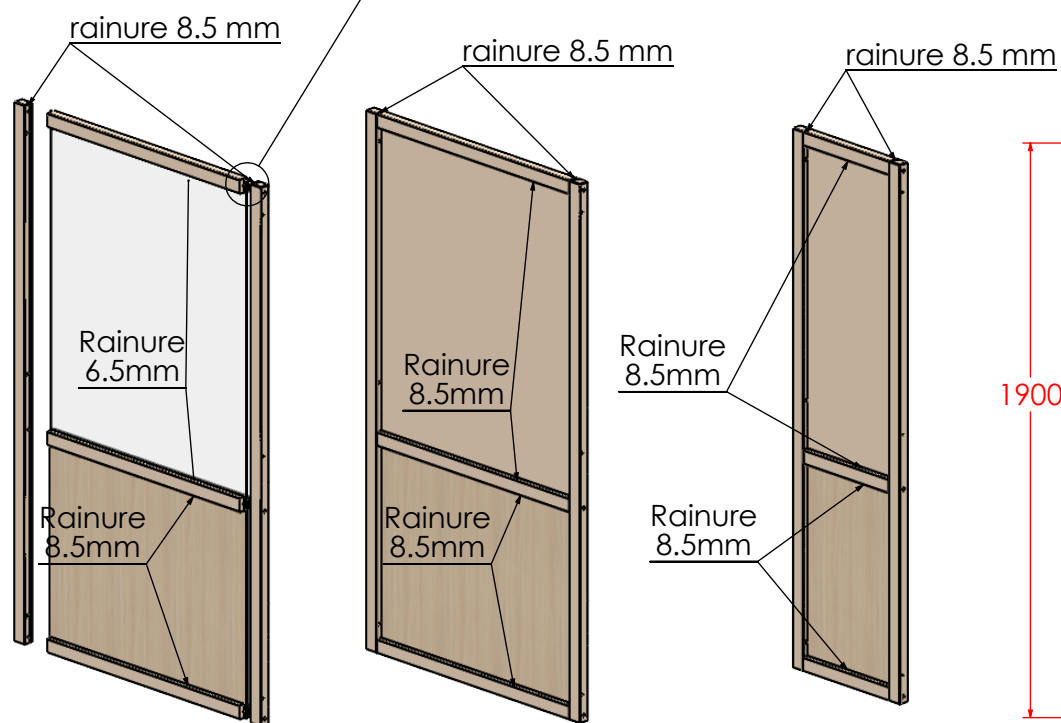
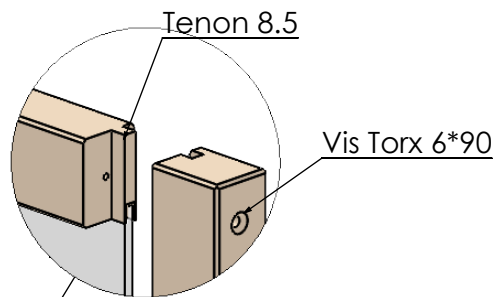

Qté: 2 vitrage

Qté: 1 vitrage + hygiaphone

Qté: 3

Qté: 3 en 500

Qté: 2 en 250

Tolérance générale: ± 0.3

Indice: **A**  
Date: **24/04/2020**  
Ech: **1:25**

**Evidences Mobiliers**  
6 rue de l'industrie  
85250 La Rabatelière  
Tel: 0820 00 21 21

Designation ensemble :  
**Vestibul 2**  
Designation pièce:  
**Cloison**

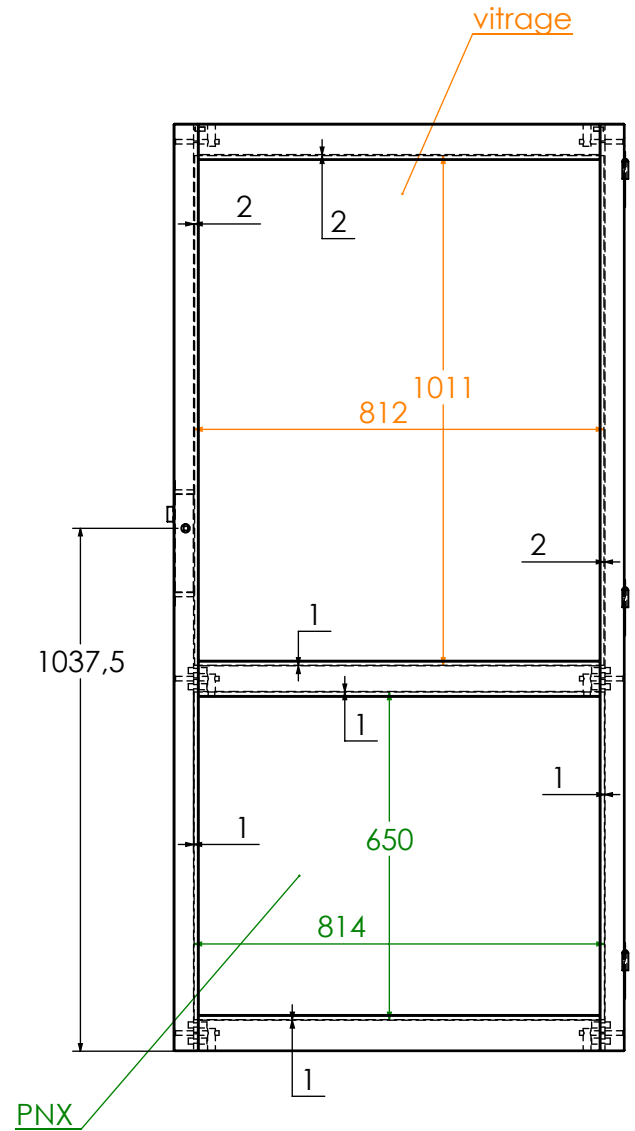
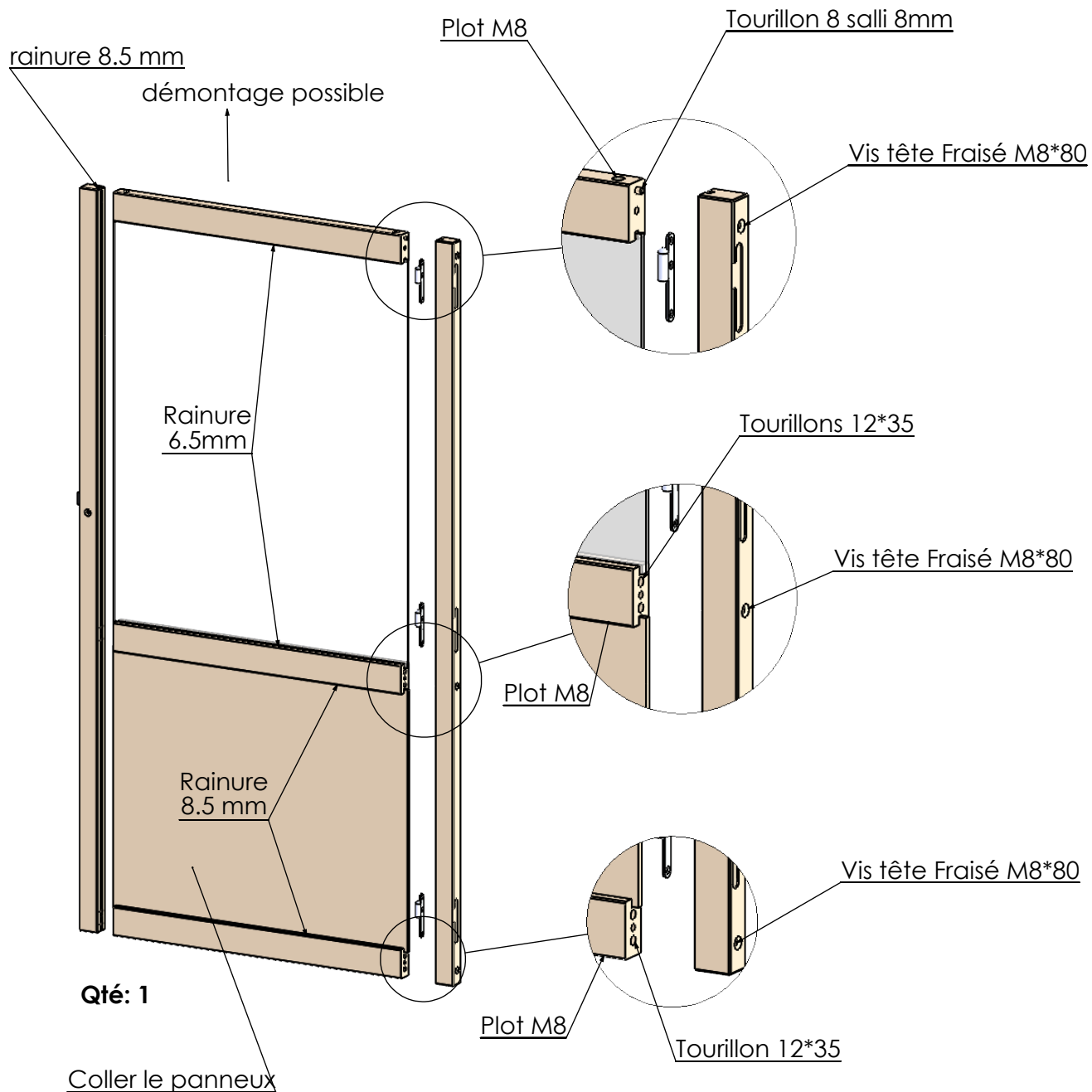

**Tolérance générale: ± 0.3**

**Indice: A**  
**Date: 24/04/2020**  
**Ech: 1:15**

**Evidences Mobiliers**  
 6 rue de l'industrie  
 85250 La Rabatelière  
 Tel: 0820 00 21 21

**Designation ensemble: Vestibul 2**  
**Designation pièce: Porte**

Ouverture extérieur

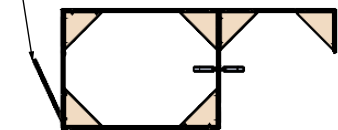

Plot M8

Tourillon 12\*35

Vis TF M8

1 Chant plat vissé sur bâti

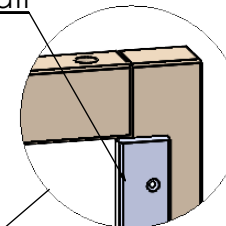

1 Serrure  
1 Guache  
1 Poigné

3 Charnières

2 vis M6\*30

1 Verin

1 seuil

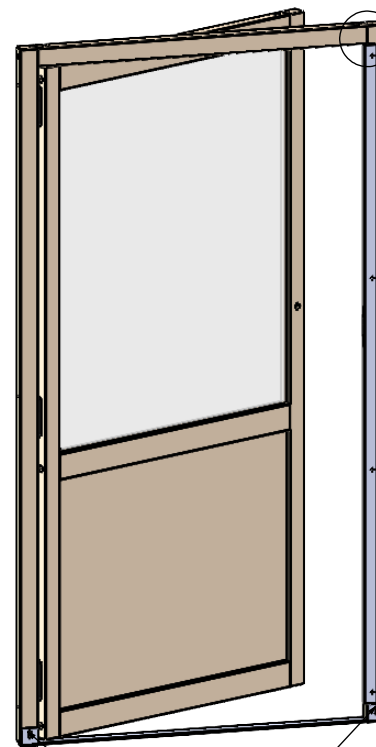

2 inserts m6

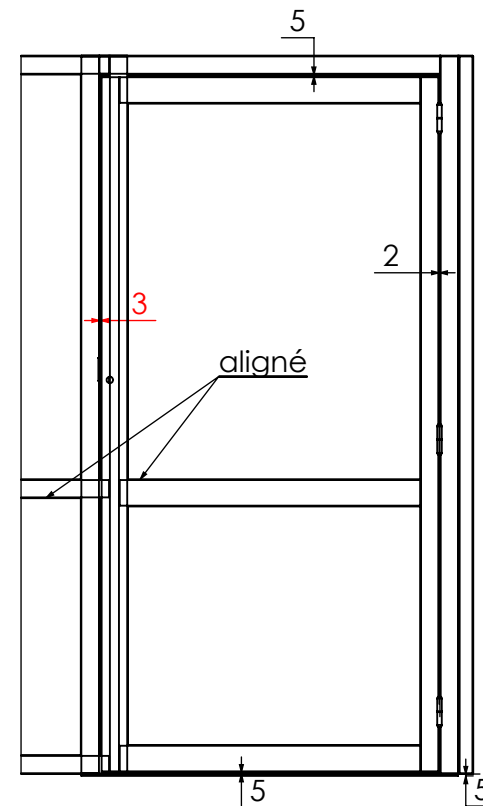

5

2

3

aligné

5

5

Tolérance générale: ± 0.3

Indice: **A**

Date: **24/04/2020**

Ech: **1:20**

**Evidences Mobiliers**

6 rue de l'industrie  
85250 La Rabatelière  
Tel: 0820 00 21 21

Designation ensemble :

**Vestibul 2**

DÉTAIL AA  
Designation pièce:

**Bloc porte**

Montant Bati de Porte : 1 MT Charnière + 1 MT Guache

Traverse haute Bati de Porte : 1

Montant cloison PNX et Vitrage : 22

Montant "T": 1

Montant "Cache": 1

Montant "angle": 4

Traverse H/B cloison PNX 500 : 6

Traverse inter cloison PNX 500 : 3

Traverse inter cloison PNX 1000 : 3

Traverse H/B cloison PNX 1000 : 9

Traverse inter cloison PNX 250 : 2

Traverse H/B cloison PNX 500 : 4

Traverse inter cloison vitrée : 3

Traverse haute cloison vitrée : 3

**Tolérance générale: ± 0.3**

Indice: A

Date: 24/04/2020

Ech: 1:30

**Evidences Mobiliers**

6 rue de l'industrie  
85250 La Rabatelière  
Tel: 0820 00 21 21

Designation ensemble :

**Vestibul 2**

Designation pièce:

**Détail Montants Traverses**